

# LE1515

## Fitting Instruction

### Batwing Seal

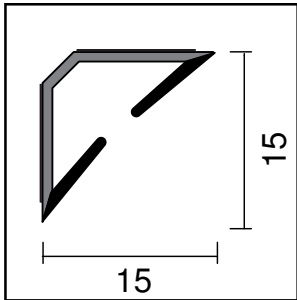

Length:

#### DESCRIPTION OF CONTENTS

- Batwing seal with self-adhesive backing
- Fitting instructions

#### TOOLS REQUIRED FOR INSTALLATION

- Tape Measure
- Scissors/Knife
- Pencil or marker

#### INSTALLATION DETAIL

It is not necessary to remove the door from its hinges.

**Note:** The Batwing Seal requires a minimum of 2mm-3mm clearance between the door stop/door face and door edge/door frame.

##### STEP 1

Remove the seal from the packaging and measure the existing head (top) and jambs (sides) of the door frame (or perimeter of the window) to determine the seal length required.

##### STEP 2

Clean the frame to ensure it is free from oil, grease or dust.

##### STEP 3

Using scissors/knife, trim the Batwing to the opening height and width of the door reveal. Cut the top corners using a jointing method as tight as possible to ensure continuity of seal. (i.e. Notch or Mitre)

##### STEP 4

Starting with the long vertical jambs, peel back the self-adhesive backing tape from both legs by approximately 150mm.

##### STEP 5

Push the seal into the top corner of the frame-stop as tightly as possible.

##### STEP 6

Progressively pull the backing tape off the seal while running a finger or appropriate blunt tool down the centre of the profile whilst ensuring that the adhesive sticks evenly to each surface.

##### STEP 7

Once the seals have been fitted to the jambs. Apply the seal to the head of the frame as per STEP 6.

#### IMPORTANT

*Do not remove and relocate seal.*

*Do not stretch the seal.*

*Ensure that the installation of this product does not impede the opening or closing of the door. It is recommended to check the adjustment of the door seal periodically to ensure the door assembly to which it is fitted, closes and latches properly.*

*The seal may be cleaned periodically without removing the door leaf from its frame.*

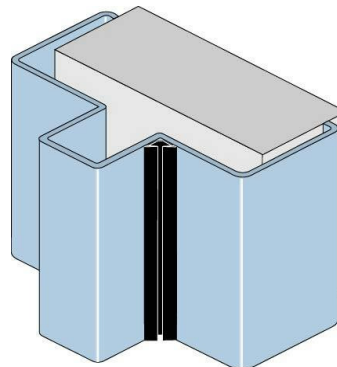
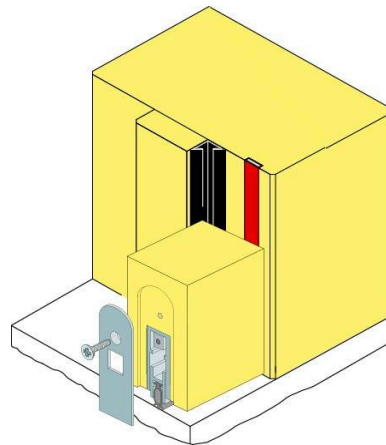

#### OTHER LORIENT ARCHITECTURAL SEALS INCLUDE: INTEGRITY™ RANGE

- |                               |                    |
|-------------------------------|--------------------|
| ■ Door Perimeter Seals        | ■ Threshold Plates |
| ■ Door Bottom Seals           | ■ Brush Seals      |
| ■ Automatic Door Bottom Seals | ■ Magnetic Seals   |

Contact your nearest Lorient office for further details.

#### NOTE

*Recommendations as to methods for use of materials and construction details are based on the experience and knowledge of Lorient and are given in good faith as a general guide and service to designers, contractors and manufacturers.*

*Lorient reserves the right to make alterations or delete any installation detail without prior notice.*

**AUSTRALIA**  
Lorient Australia

Tel 1300 858 010

**ASIA PACIFIC**  
Lorient Pacific Limited Hong Kong

Tel: (+852) 2505 0328

**EUROPE**  
Lorient Polyproducts Ltd UK

Tel: (+44) 1626 834252

**MIDDLE EAST**  
Lorient Middle East Building Materials Trading LLC Dubai

Tel (+971) 4267 4339  
Fax (+971) 4267 5339